

M-QFN12W.5
DWG 451250

M-QFN16W.5
DWG 451650

M-QFN24W.5
DWG 452450

M-QFN32W.5
DWG 453250

M-QFN40W.5
DWG 454050

M-QFN48W.5
DWG 454850

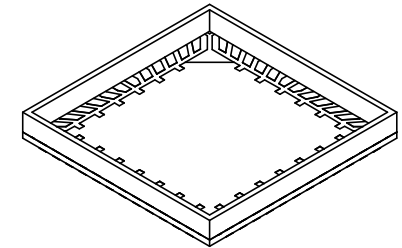
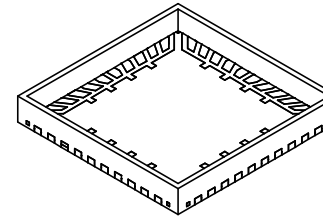
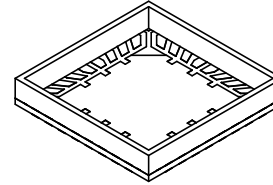
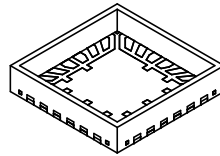
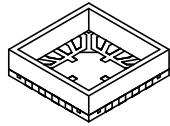
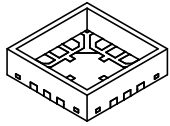

12L - 3X3mm
PITCH 0.5mm

16L - 3X3mm
PITCH 0.5mm

24L - 4X4mm
PITCH 0.5mm

32L - 5X5mm
PITCH 0.5mm

40L - 6X6mm
PITCH 0.5mm

48L - 7X7mm
PITCH 0.5mm

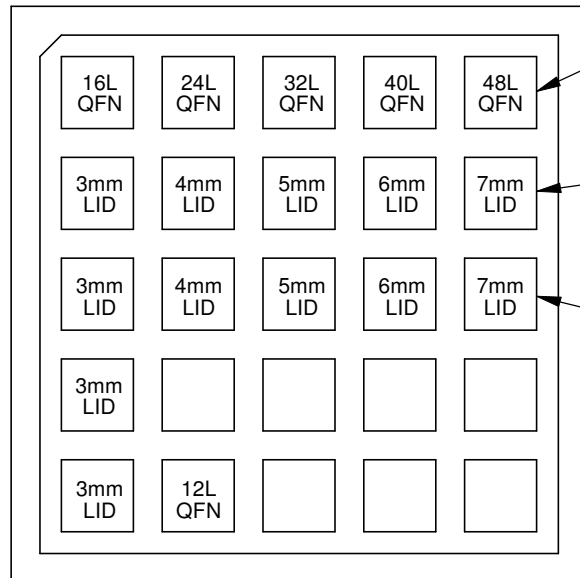

2-INCH WAFFLE PACK
TOP VIEW

M-QFN PACKAGES
OPEN CAVITY
1X EACH

WHITE LIDS
1X EACH
ROGERS RO4003C

BLACK LIDS
1X EACH
BT

KIT P/N 450000 - B.O.M. CONTENTS						
QTY	DWG NBR	PART NUMBER	PINS	SIZE	PITCH	DESCRIPTION
1	451250	M-QFN12W.5	12L	3X3mm	0.5mm	OPEN (AIR) CAVITY QFN PACKAGE
1	451650	M-QFN16W.5	16L	3X3mm	0.5mm	
1	452450	M-QFN24W.5	24L	4X4mm	0.5mm	
1	453250	M-QFN32W.5	32L	5X5mm	0.5mm	
1	454050	M-QFN40W.5	40L	6X6mm	0.5mm	
1	454850	M-QFN48W.5	48L	7X7mm	0.5mm	FLAT LID ROGERS RO4003C WHITE
2	203942	T-LID3W-WHITE	--	3X3mm	--	
1	204942	T-LID4W-WHITE	--	4X4mm	--	
1	205942	T-LID5W-WHITE	--	5X5mm	--	
1	206942	T-LID6W-WHITE	--	6X6mm	--	
1	207942	T-LID7W-WHITE	--	7X7mm	--	FLAT LID BT BLACK
2	203102	T-LID3W-BLACK	--	3X3mm	--	
1	204102	T-LID4W-BLACK	--	4X4mm	--	
1	205102	T-LID5W-BLACK	--	5X5mm	--	
1	206102	T-LID6W-BLACK	--	6X6mm	--	
1	207102	T-LID7W-BLACK	--	7X7mm	--	

CONTACT:
MIRROR SEMICONDUCTOR
TEL: 1-866-404-8800
EMAIL: info@MirrorSemi.com
www.MirrorSemi.com

Notes: (Unless Otherwise Specified).

- 1) M-QFN OPEN (AIR) CAVITY PACKAGES.
- 2) PLATING: Ni/Pd/Au.
- 3) LEAD FRAME: Cu COPPER (C-194F/H).
- 4) BODY: PLASTIC SEMICONDUCTOR GRADE.
- 5) CONFORMS TO JEDEC OUTLINE.

TOLERANCE UNLESS NOTED		APPROVALS	DATE				
X.X	+/- 0.3	DRAWN J. Hines	5/3/2011				
X.XX	+/- 0.03						
X.XXX	+/- 0.003	ENG		SCALE	SIZE	DRAWING NO.	REV
ANGLES +/- 0.5°		MFG		5:1	A	450000	A
ALL DIMENSIONS IN		QA		DO NOT SCALE DRAWING		SHEET 1 OF 4	
<input checked="" type="checkbox"/> INCHES <input checked="" type="checkbox"/> MILLIMETERS		CUST					
THIRD ANGLE PROJECTION		REVISED					

M-QFN PACKAGE OUTLINE DRAWING

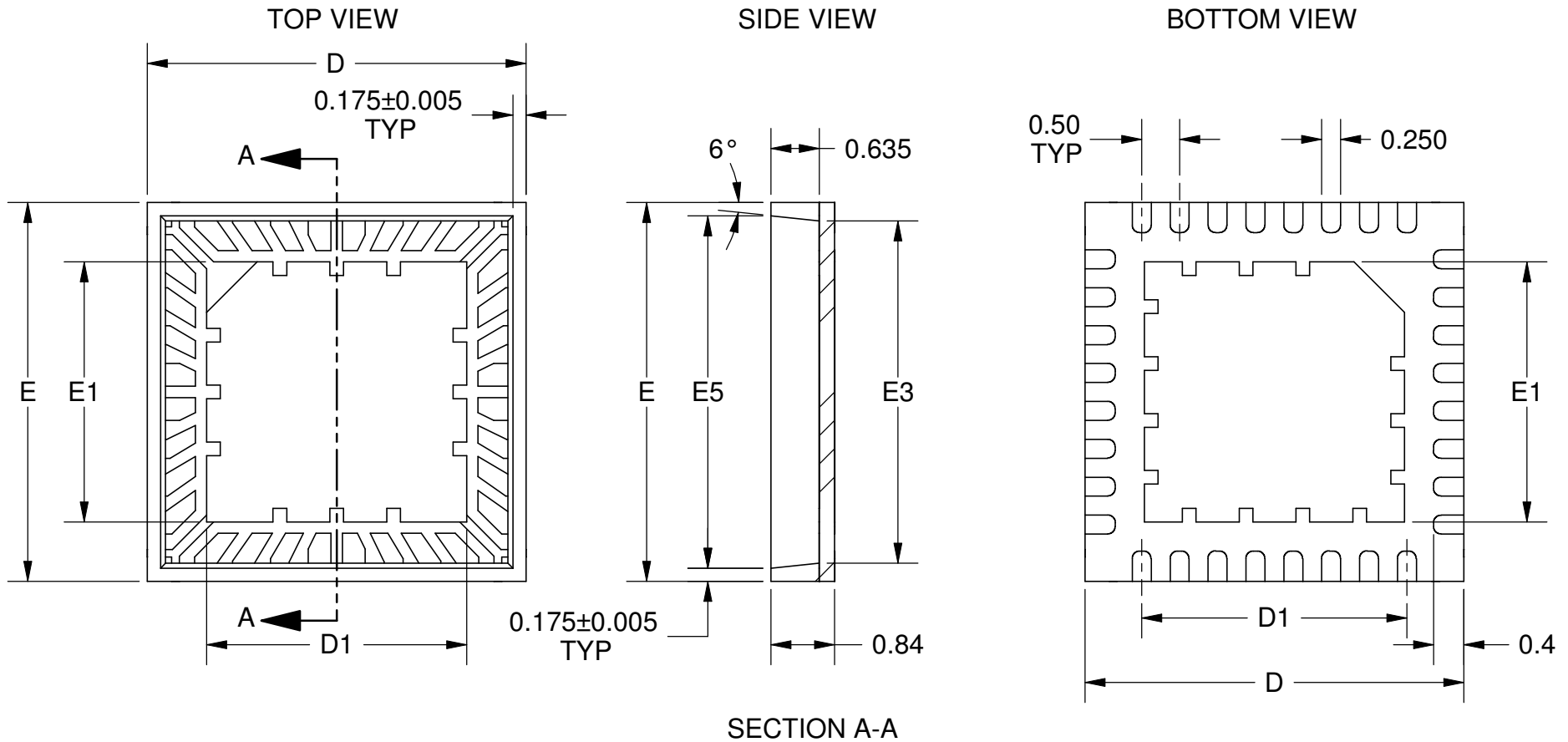

M-QFN PACKAGE OUTLINE (mm)						
DWG NBR	PART NUMBER	NBR PINS	E D	E1 D1	E3 D3	E5 D5
451250	M-QFN12W.5	12L	3	1.4	2.517	2.65
451650	M-QFN16W.5	16L	3	1.4	2.517	2.65
452450	M-QFN24W.5	24L	4	2.4	3.517	3.65
453250	M-QFN32W.5	32L	5	3.4	4.517	4.65
454050	M-QFN40W.5	40L	6	4.4	5.517	5.65
454850	M-QFN48W.5	48L	7	5.4	6.517	6.65

CONTACT:
 MIRROR SEMICONDUCTOR
 TEL: 1-866-404-8800
 EMAIL: info@MirrorSemi.com
 www.MirrorSemi.com

TITLE M-QFN EVALUATION KIT OPEN CAVITY PACKAGES			
SCALE 12:1	SIZE A	DRAWING NO. 450000	REV A
DO NOT SCALE DRAWING		SHEET 2 OF 4	

M-QFN40
40L

40 39 38 37 36 35 34 33 32 31

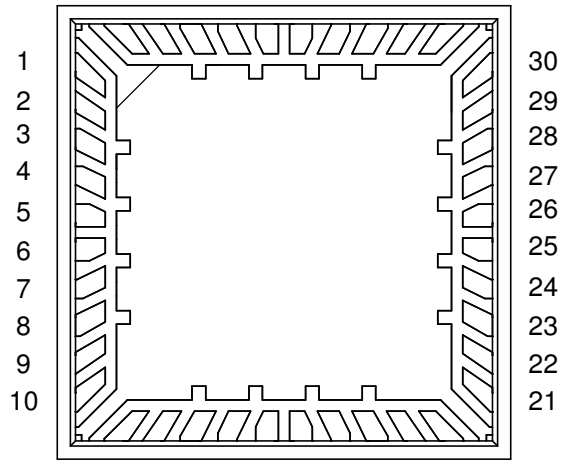

11 12 13 14 15 16 17 18 19 20

M-QFN24
24L

24 23 22 21 20 19

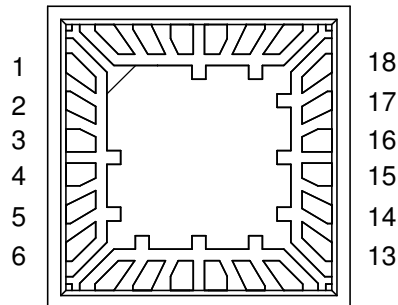

7 8 9 10 11 12

M-QFN48
48L

48 47 46 45 44 43 42 41 40 39 38 37

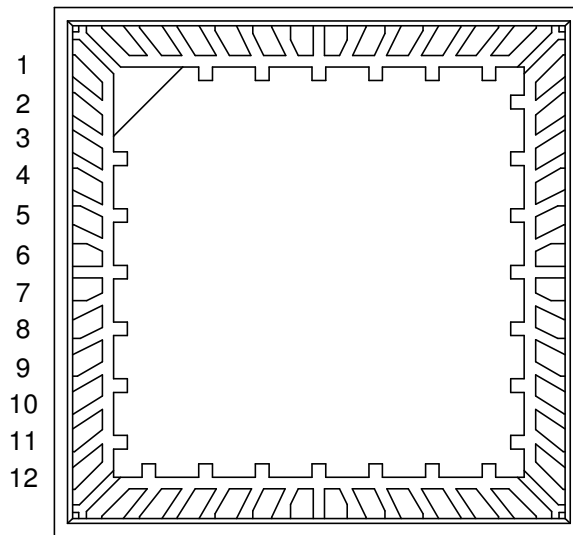

13 14 15 16 17 18 19 20 21 22 23 24

12 11 10

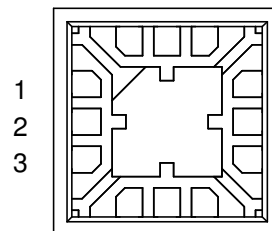

4 5 6

M-QFN12
12L

M-QFN32
32L

32 31 30 29 28 27 26 25

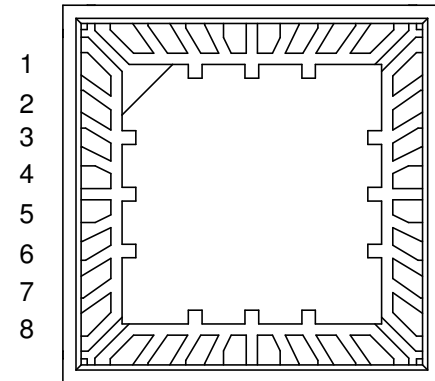

9 10 11 12 13 14 15 16

M-QFN16
16L

16 15 14 13

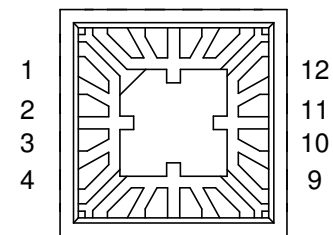

5 6 7 8



TITLE M-QFN EVALUATION KIT
OPEN CAVITY PACKAGES

SCALE 10:1	SIZE A	DRAWING NO. 450000	REV A
---------------	-----------	-----------------------	----------

DO NOT SCALE DRAWING

SHEET 3 OF 4

FLAT LID (TAPE ON)

TOP VIEW

SIDE VIEW

BOTTOM VIEW

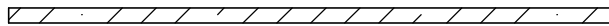
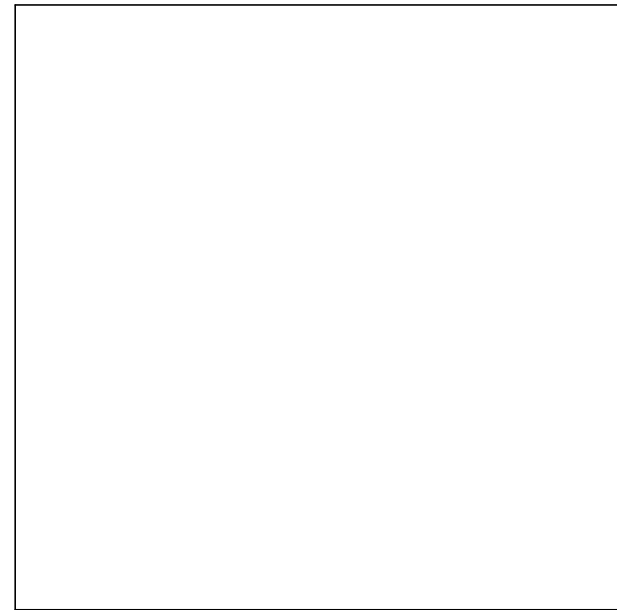
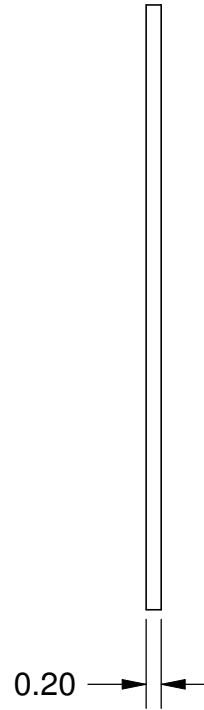
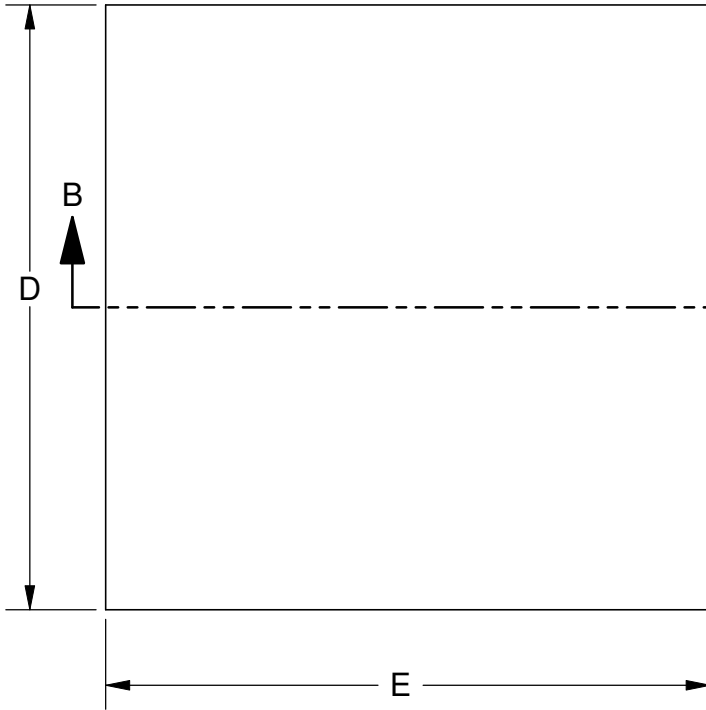

SECTION B-B

Notes: (Unless Otherwise Specified).

- 1) MATERIAL:
 - A) LID: ROGERS RO4003C = WHITE, BT = BLACK.
 - B) PREFORM: NONE.
- 2) LID ATTACH:
 - REMOVABLE: USE KAPTON TAPE OR EQUIVALENT.
 - PERMANENT: USE EPOXY PER CUSTOMER CHOICE.
- 3) STORAGE LIFE: NO LIMIT @ 25°C.
- 4) COLOR:
 - STANDARD: WHITE OR BLACK.

DIMENSION TABLE (mm)					
QFN SIZE	D/E	DWG	PART NBR	DWG	PART NBR
3X3	3.0	203942	T-LID3W-WHITE	203102	T-LID3W-BLACK
4X4	4.0	204942	T-LID4W-WHITE	204102	T-LID4W-BLACK
5X5	5.0	205942	T-LID5W-WHITE	205102	T-LID5W-BLACK
6X6	6.0	206942	T-LID6W-WHITE	206102	T-LID6W-BLACK
7X7	7.0	207942	T-LID7W-WHITE	207102	T-LID7W-BLACK

			
TITLE M-QFN EVALUATION KIT OPEN CAVITY PACKAGES			
SCALE 10:1	SIZE A	DRAWING NO. 450000	REV A
DO NOT SCALE DRAWING		SHEET 4 OF 4	