

M-QFN16W.5  
DWG 451650

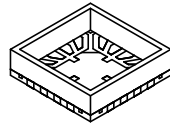

16L - 3X3mm  
PITCH 0.5mm

M-QFN24W.5  
DWG 452450

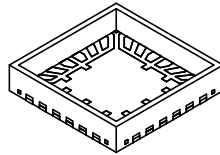

24L - 4X4mm  
PITCH 0.5mm

M-QFN32W.5  
DWG 453250

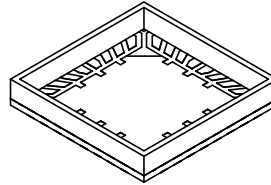

32L - 5X5mm  
PITCH 0.5mm

M-QFN40W.5  
DWG 454050

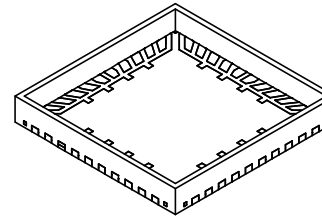

40L - 6X6mm  
PITCH 0.5mm

M-QFN48W.5  
DWG 454850

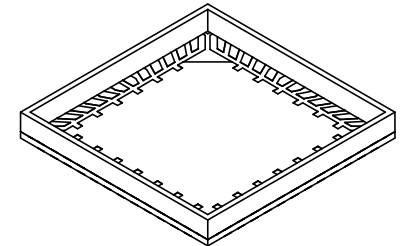

48L - 7X7mm  
PITCH 0.5mm

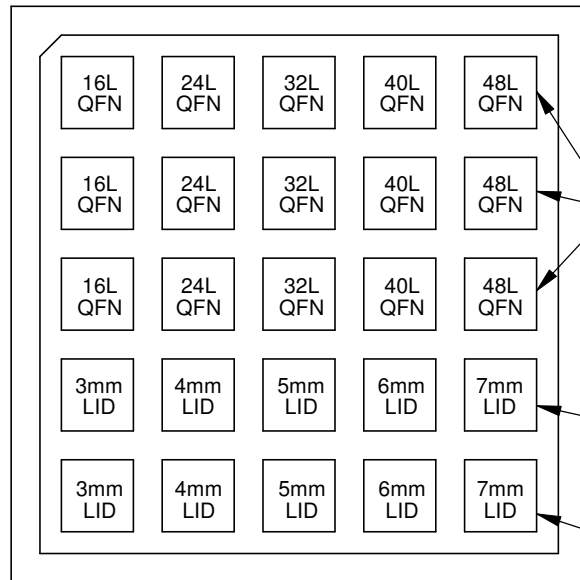

2-INCH WAFFLE PACK  
TOP VIEW

M-QFN PACKAGES  
OPEN CAVITY  
3X EACH

WHITE LIDS  
3X EACH  
ROGERS RO4003C

BLACK LIDS  
3X EACH  
BT

KIT P/N 450045 - B.O.M. CONTENTS						
QTY	DWG NBR	PART NUMBER	PINS	SIZE	PITCH	DESCRIPTION
3	451650	M-QFN16W.5	16L	3X3mm	0.5mm	OPEN (AIR) CAVITY QFN PACKAGE
3	452450	M-QFN24W.5	24L	4X4mm	0.5mm	
3	453250	M-QFN32W.5	32L	5X5mm	0.5mm	
3	454050	M-QFN40W.5	40L	6X6mm	0.5mm	
3	454850	M-QFN48W.5	48L	7X7mm	0.5mm	FLAT LID ROGERS RO4003C WHITE
3	203942	T-LID3W-WHITE	--	3X3mm	--	
3	204942	T-LID4W-WHITE	--	4X4mm	--	
3	205942	T-LID5W-WHITE	--	5X5mm	--	
3	206942	T-LID6W-WHITE	--	6X6mm	--	
3	207942	T-LID7W-WHITE	--	7X7mm	--	
3	203102	T-LID3W-BLACK	--	3X3mm	--	
3	204102	T-LID4W-BLACK	--	4X4mm	--	
3	205102	T-LID5W-BLACK	--	5X5mm	--	
3	206102	T-LID6W-BLACK	--	6X6mm	--	
3	207102	T-LID7W-BLACK	--	7X7mm	--	

CONTACT:  
MIRROR SEMICONDUCTOR  
TEL: 1-866-404-8800  
EMAIL: info@MirrorSemi.com  
www.MirrorSemi.com

Notes: (Unless Otherwise Specified).

- 1) M-QFN OPEN (AIR) CAVITY PACKAGES.
- 2) PLATING: Ni/Pd/Au.
- 3) LEAD FRAME: Cu COPPER (C-194F/H).
- 4) BODY: PLASTIC SEMICONDUCTOR GRADE.
- 5) CONFORMS TO JEDEC OUTLINE.

TOLERANCE UNLESS NOTED		APPROVALS	DATE				
X.X	+/- 0.3	DRAWN J. Hines	3/24/2011				
X.XX	+/- 0.03						
X.XXX	+/- 0.003						
ANGLES +/- 0.5°		ENG		SCALE 5:1    SIZE A    DRAWING NO. 450045    REV A			
ALL DIMENSIONS IN		MFG					
<input type="checkbox"/> INCHES <input checked="" type="checkbox"/> MILLIMETERS		QA		DO NOT SCALE DRAWING			
THIRD ANGLE PROJECTION		CUST					
		REVISED					

# M-QFN PACKAGE OUTLINE DRAWING

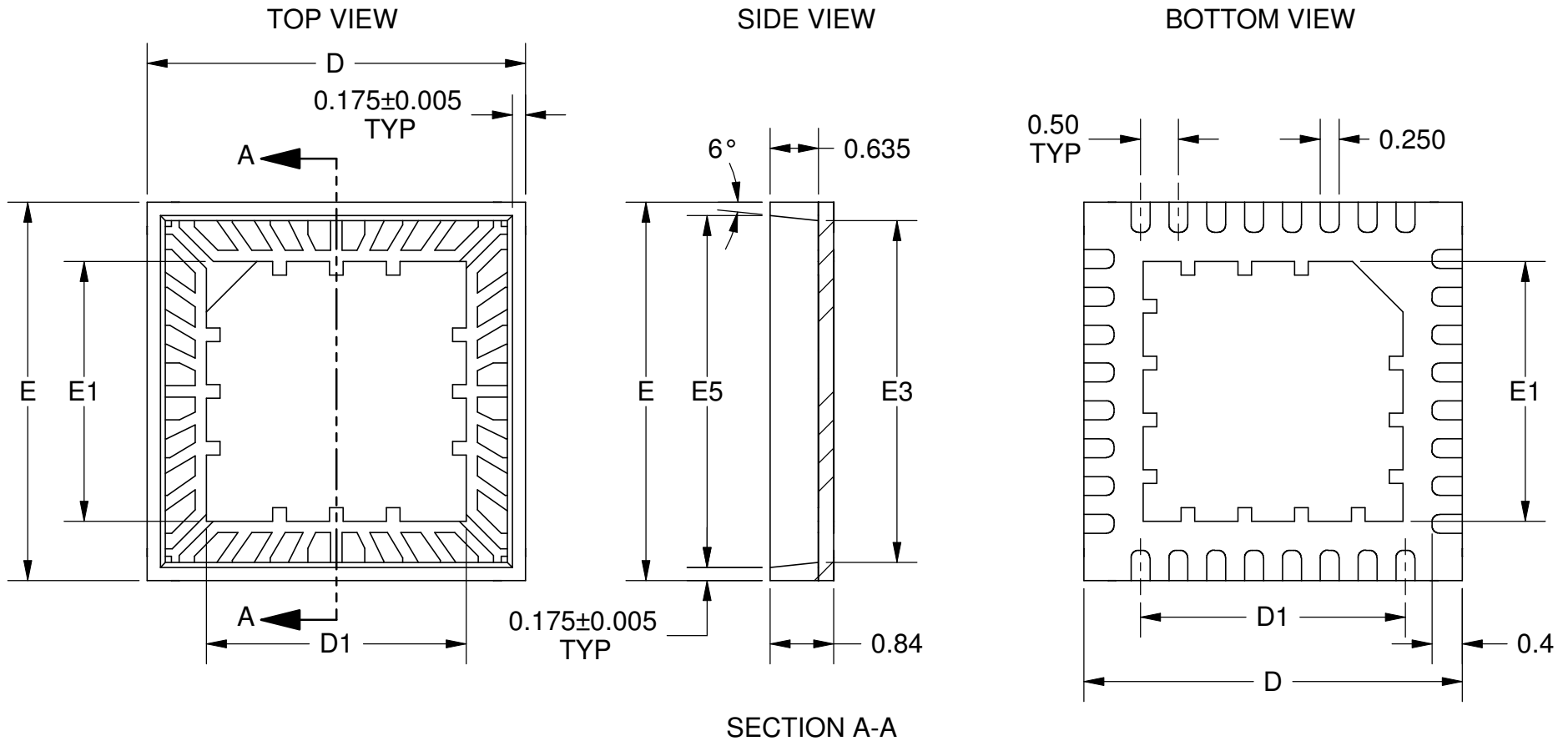

M-QFN PACKAGE OUTLINE (mm)						
DWG NBR	PART NUMBER	NBR PINS	E D	E1 D1	E3 D3	E5 D5
451650	M-QFN16W.5	16L	3	1.4	2.517	2.65
452450	M-QFN24W.5	24L	4	2.4	3.517	3.65
453250	M-QFN32W.5	32L	5	3.4	4.517	4.65
454050	M-QFN40W.5	40L	6	4.4	5.517	5.65
454850	M-QFN48W.5	48L	7	5.4	6.517	6.65

CONTACT:  
 MIRROR SEMICONDUCTOR  
 TEL: 1-866-404-8800  
 EMAIL: info@MirrorSemi.com  
 www.MirrorSemi.com

TITLE M-QFN EVALUATION KIT OPEN CAVITY PACKAGES			
SCALE 12:1	SIZE A	DRAWING NO. 450045	REV A
DO NOT SCALE DRAWING		SHEET 2 OF 4	

M-QFN40  
40L

40 39 38 37 36 35 34 33 32 31

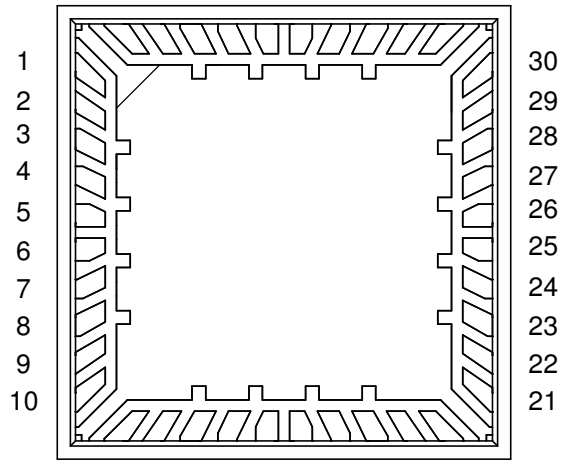

11 12 13 14 15 16 17 18 19 20

M-QFN24  
24L

24 23 22 21 20 19

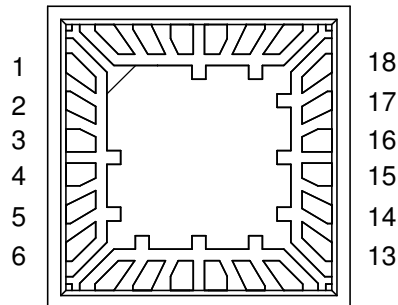

7 8 9 10 11 12

M-QFN48  
48L

48 47 46 45 44 43 42 41 40 39 38 37

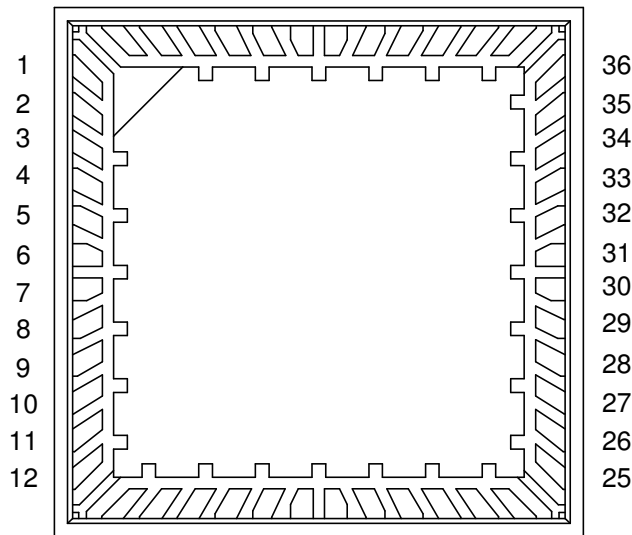

13 14 15 16 17 18 19 20 21 22 23 24

M-QFN32  
32L

32 31 30 29 28 27 26 25

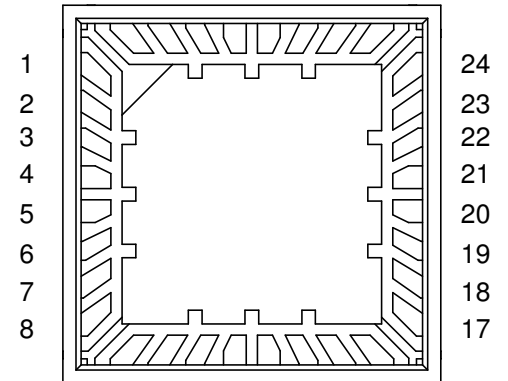

9 10 11 12 13 14 15 16

M-QFN16  
16L

16 15 14 13

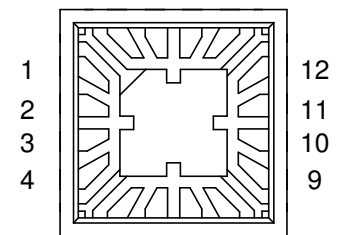

5 6 7 8



TITLE M-QFN EVALUATION KIT  
OPEN CAVITY PACKAGES

SCALE 10:1	SIZE A	DRAWING NO. 450045	REV A
---------------	-----------	-----------------------	----------

DO NOT SCALE DRAWING

SHEET 3 OF 4

# FLAT LID (TAPE ON)

TOP VIEW

SIDE VIEW

BOTTOM VIEW

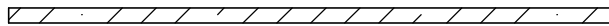
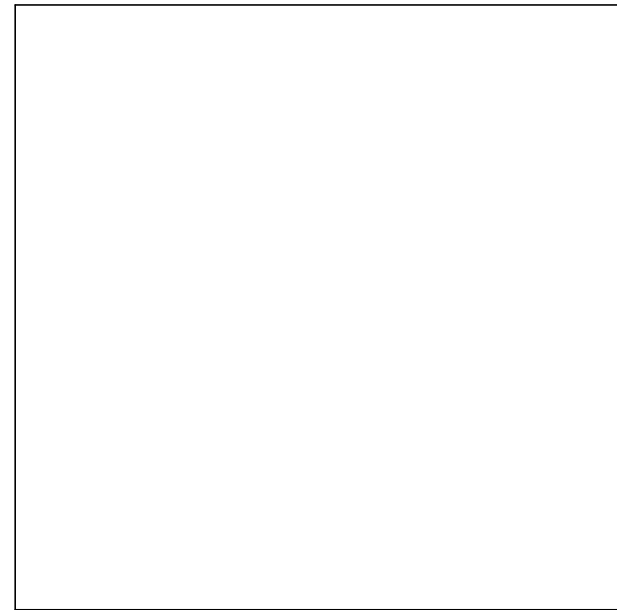
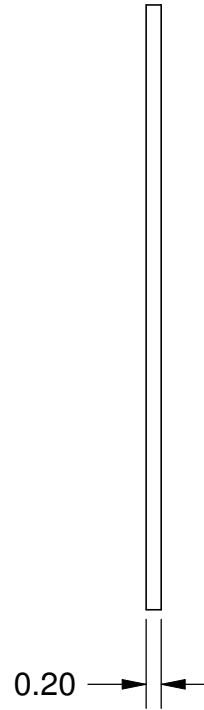
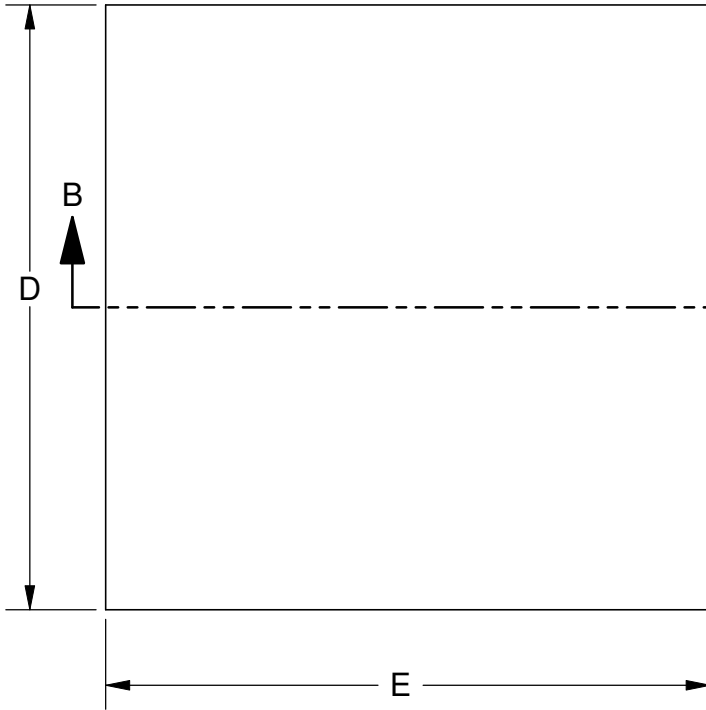

SECTION B-B

Notes: (Unless Otherwise Specified).

- 1) MATERIAL:
  - A) LID: ROGERS RO4003C = WHITE, BT = BLACK.
  - B) PREFORM: NONE.
- 2) LID ATTACH:
  - REMOVABLE: USE KAPTON TAPE OR EQUIVALENT.
  - PERMANENT: USE EPOXY PER CUSTOMER CHOICE.
- 3) STORAGE LIFE: NO LIMIT @ 25°C.
- 4) COLOR:
  - STANDARD: WHITE OR BLACK.

DIMENSION TABLE (mm)					
QFN SIZE	D/E	DWG	PART NBR	DWG	PART NBR
3X3	3.0	203942	T-LID3W-WHITE	203102	T-LID3W-BLACK
4X4	4.0	204942	T-LID4W-WHITE	204102	T-LID4W-BLACK
5X5	5.0	205942	T-LID5W-WHITE	205102	T-LID5W-BLACK
6X6	6.0	206942	T-LID6W-WHITE	206102	T-LID6W-BLACK
7X7	7.0	207942	T-LID7W-WHITE	207102	T-LID7W-BLACK

			
TITLE M-QFN EVALUATION KIT OPEN CAVITY PACKAGES			
SCALE 10:1	SIZE A	DRAWING NO. 450045	REV A
DO NOT SCALE DRAWING		SHEET 4 OF 4	