

TOP VIEW
CLOSED SIDE

SIDE VIEW

BOTTOM VIEW
OPEN SIDE

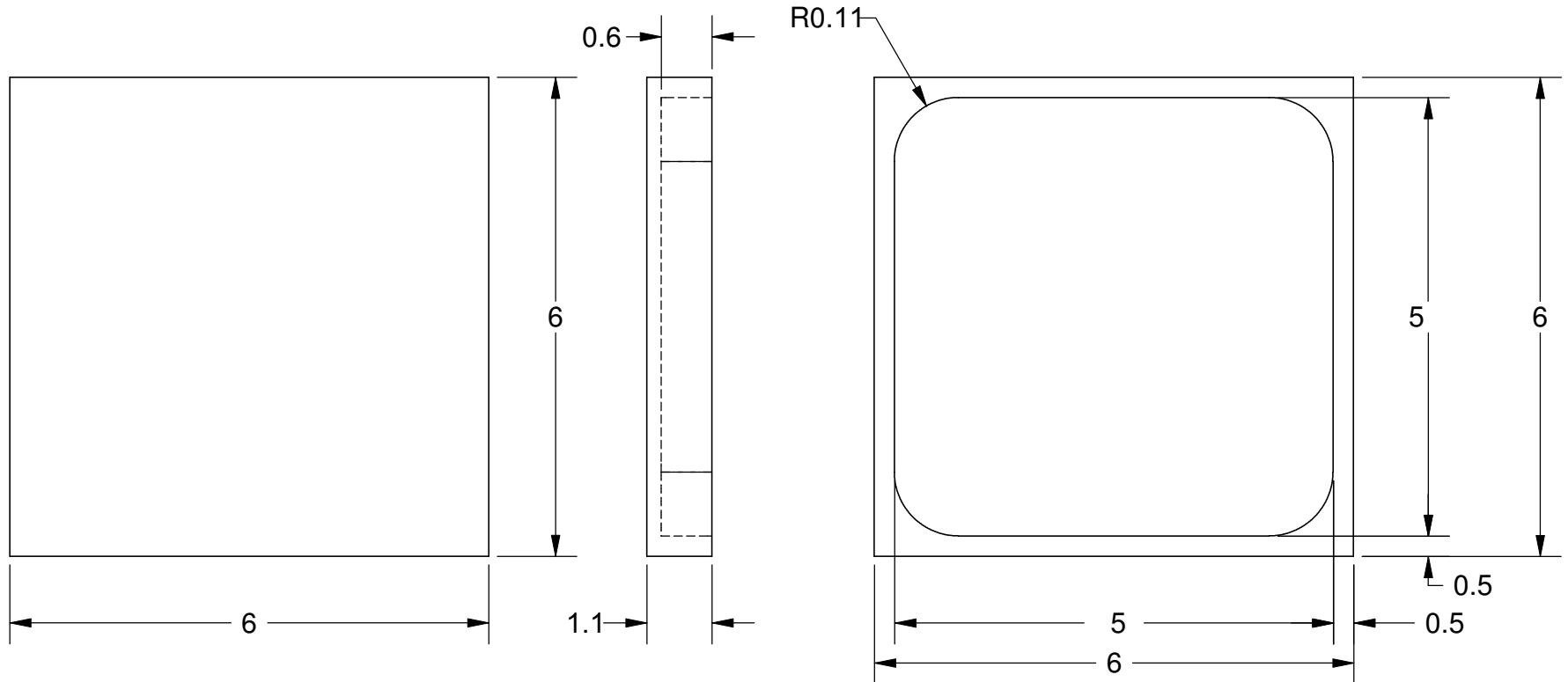

Notes: (Unless Otherwise Specified).

1) MATERIAL:

- A) LID: BOROSILICATE GLASS
- B) PREFORM: NONE.

2) LID ATTACH:

- A) REMOVABLE: USE KAPTON TAPE OR EQUIVALENT.
- B) PERMANENT: USE EPOXY PER CUSTOMER CHOICE.

3) STORAGE LIFE: NO LIMIT @ 25 °C.

4) DIMENSIONS IN mm.

TOLERANCE UNLESS NOTED		APPROVALS	DATE	TopLine [®]			
X.X	+/- 0.05	DRAWN J. Hines	3/24/2011				
X.XX	+/- 0.01						
X.XXX	+/- 0.005						
ANGLES	+/- 0.5°	ENG		SCALE 12:1 SIZE A DRAWING NO. 206020 REV A			
ALL DIMENSIONS IN		MFG					
<input type="checkbox"/> INCHES	<input checked="" type="checkbox"/> MILLIMETERS	QA		DO NOT SCALE DRAWING SHEET 1 OF 1			
THIRD ANGLE PROJECTION		CUST					
		REVISED					